

CLUB STATION
K6SON

Short Skip

The Newsletter of

Sonoma County Radio Amateurs, Inc.

P.O. Box 116, Santa Rosa, CA 95402-0116 707-538-2931

<http://www.sonomacountyradioamateurs.com>

Repeaters:

English Hill: 147.315+ 88.5 / 224.180+ 88.5 /
441.375+ 88.5

Castle Rock: 147.315+ 156.7

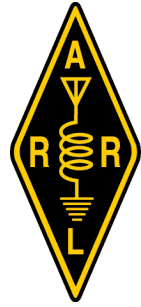

REPEATER STATION
W6SON

Volume 41, Number 5

May 2016

ANTENNA POLARIZATION EXPLAINED

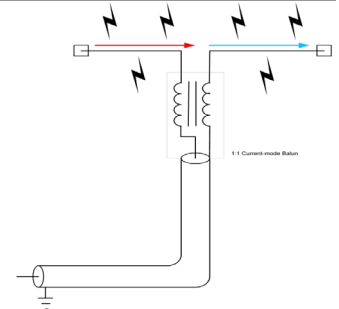

Antenna polarization may be one of the least understood properties of a wireless signal. If you are installing many [antennas](#) in one location, like on a tower, polarization is an important piece of the puzzle that you'll need to take into consideration. Here we give you a quick overview on antenna polarization.

Polarization is determined by the way an antenna is mounted, usually horizontally or vertically. To ensure optimal network performance only like-polarized antennas should be used in point-to-point wireless applications. It is possible to establish a wireless link using antennas with different polarities but network performance and connectivity will suffer.

The big advantage of using different antenna polarization schemes is to reduce interference. For example when mounting several antennas on a tower, it is best to stagger vertically and horizontally polarized antennas to reduce interference.

If horizontal or vertical polarization won't work for your wireless application there are dual-polarized, cross-polarized and circular-polarized antenna options to explore.

[Dual-polarized antennas](#) feature two antenna elements in a single physical package (radome), one that is vertically polarized and one that is horizontally polarized. When properly installed, dual polarized antennas can communicate with both vertically and horizontally polarized antennas. An advantage of dual polarity antenna is that you get basically two antennas in one package, this saves space and money. These types of antennas are often used with MIMO (multiple-in/multiple-out) wireless access points and CPE devices.

[Cross-polarized antennas](#) sometimes referred to as X-Pol antennas, feature two elements in one package. One element is +45° polarized and the other is -45° polarized. The two opposing 45° angle of the elements produces a cross or X orientation. Using a cross polarized antenna with vertically and horizontally polarized antennas further reduces interference.

Continued on page 2...





Polarization explained continued from page 1...

[Circular-polarized antennas](#) have equal response to either horizontal or vertical polarized antennas. These antennas are designed to either support right hand or left hand polarization to suit varied wireless connectivity applications. Using a circular-polarized antenna on a fixed access point can be beneficial if the linear-polarized remote links are constantly moving.

Antenna Polarization Options:

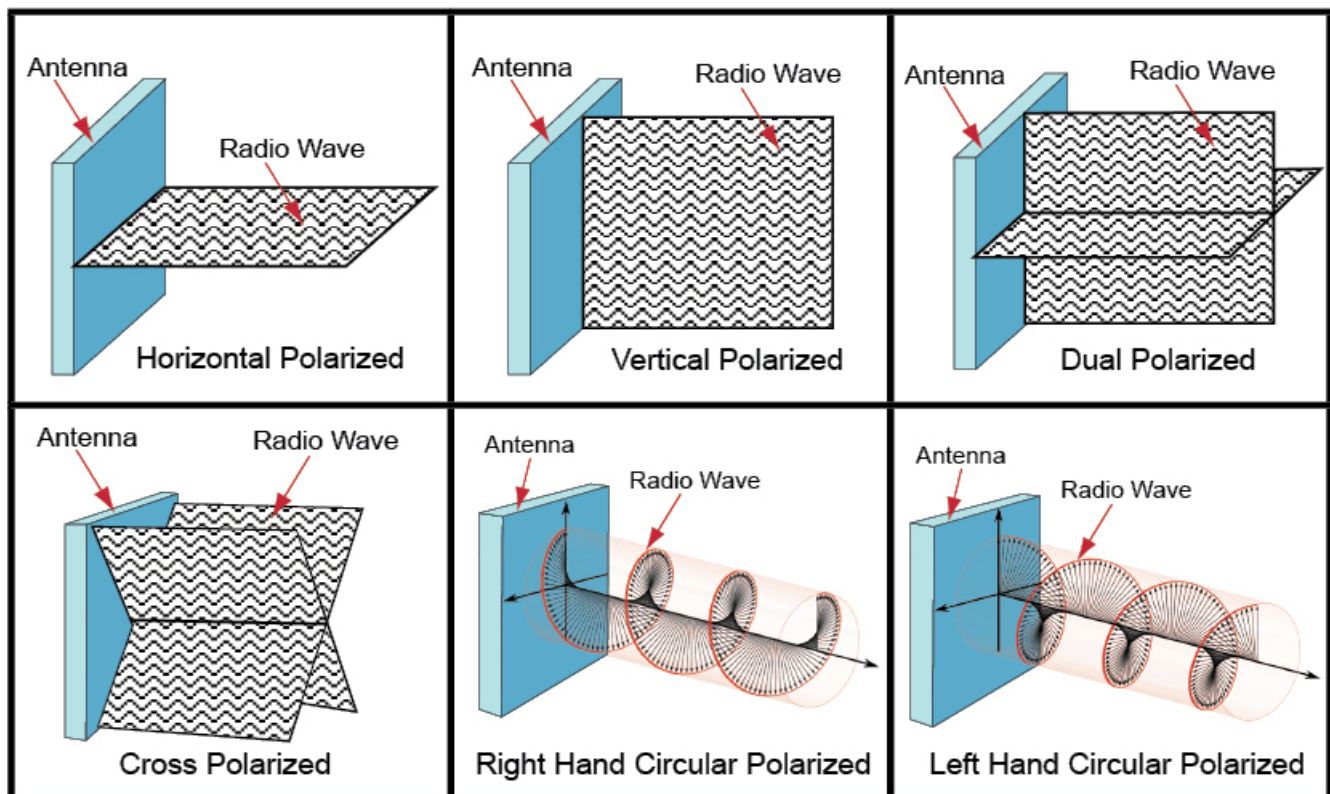

From L-Com Global Connectivity, <http://www.l-com.com>

SCRA Website Forum

So how many of you know that the SCRA website has a forum page? Its there for all members to use.

There is a Section for Activities, Announcements and News, Public Service, and Technical Issues.

To visit the site,

Navigate to the SCRA website,

Log in as a member

Click on Member Area, then Forums

While you are on the individual Forum pages, make sure to click on SUBSCRIBE. This will send you an

email when a new question gets posted.

Don't worry about your inbox getting flooded with junk emails. Only valid members can post to the site.

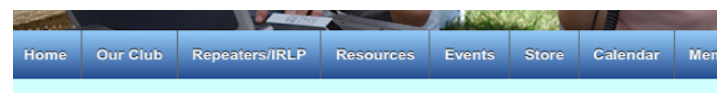

Announcements and News

Home > Forums > Announcements and News [Subscribe](#) Use the Subscribe Button

This forum contains 22 topics and 10 replies, and was last updated by wb6jao 4 months ago.

Viewing 15 topics - 1 through 15 (of 22 total)

Topic	Voices
Free to a good home - Old (1970-80s) Radio Gear	1

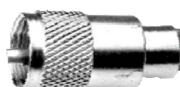

PRESIDENT'S MESSAGE MAY 2016

Happy Spring!!

A third of the year has come and gone. Are we having fun yet? This month's message has various topics:

WELCOME to our new members:

Troy KK6NEB; Tom AF6TB; Mike KI6VIN; Michael KC-6SSE; Aaron KK6ZDB; John

KK6DQG; Jim KI6RWG; Guy Bachelor; Don KJ6SED; Dave W6DGC; Chris KM6BPS; Bill KM6BYD; Alan KD6NT. (If I missed anyone, please bring it to my attention). Hope to meet you at our many activities. Volunteer. We could use your help.

Welcome to our April Meeting Guests: Pete KG6YKO and Brian White (both representing the Mendo Rally), Alan KE6IDU, Marcus KG6GHW, James KI6RWG, Beth KK6UVC and her son Nathan, Bill Dornbush a former ham from the Red Cross. Ed N2WD, and Chris KM6BPS.

NET CONTROL is one way you can help. We need a Net Controller for our Tuesday night Nets. Every week. This is where we stay in contact, learn how to communicate via radio, keep up our skills, hear what is happening around the Ham World, and get familiar with first names and call signs. The Net Script is to be used when doing the Net. The format has been worked out over time and everyone knows the format, so do not deviate from it. You can choose the manner in which you do the roll call ~ be it alpha by first name or the call sign suffix (that portion of the call sign that comes after the number), or simply random 3 -5 at a time. A random roll call does create a lot of doubling/tripling which takes time to unravel, but it's good practice for the Net Controller. Contact me via email (k6son@arrl.net), or speak up at our meeting to get on the schedule. Please make sure you have a full hour to stay in control as it is the Net Controller's responsibility to open and close the net. If you find you have a conflict, contact me and we will find someone else to take your place. Life happens and we understand that.

KUDOS to our Education Team for a successful Tech Class and Beginning Radio Session; to our VE Com-

mittee for their first testing session of the year; the Public Service group for getting us off to what we hope will be another successful public service season; and to all the other committees for meeting and planning the next four month. Lots of fun and activities coming up. Get involved.

COMING UP is the VOMARK HAM FEST, WINE COUNTRY CENTURY, HUMAN RACE, TOUR D'CALIFORNIA, MONTE RIO VINEMAN, another VE SESSION, TERRIBLE TWO, FIELD DAY, Tour d'Organics, another TECH CLASS, special guest Dr. ED FONG PRESENTATION, and MENDO RALLY. Whoo! What a summer!! Are you ready??

THE SCRA BROCHURE has been updated and will be made available to all members at our monthly Membership and Board Meetings. Thanks to Charlie kz6t and John wb6frz.

If SCRA is not providing activities that interest you, why not speak up and let us know what will interest you ~ not too late. Email me = k6son@att.net.

See you at the May Membership Meeting, and have a great summer!

Iola kk6hre
SCRA 2016 President.

MAY MEETING PROGRAM

To Be Announced
Check the Weekly Blog for Updates

JOIN ARRL, THE AMERICAN RADIO RELAY LEAGUE

The ARRL is the national organization of Amateur Radio. It represents Amateur Radio at International Conferences and before the FCC. Get the monthly QST magazine, insurance for your equipment and too many other benefits to mention here. Click <http://www.arrl.org/membership/>



If you are not getting the ARRL San Francisco Section news by e-mail and you are an ARRL member, be sure to subscribe under your Members Only information or go to this Web site:

<http://www.arrl.org/Groups/view/san-francisco>

2015 Club Officers

President	Iola Beckley	KK6HRE
Vice President	Brian Torr	N6IY
Secretary	Dave Harrison	W6IBC
Treasurer	Wells Wagner	KK6EXC
Director	Joe Fortuna	K6AWA
	ShelleyRae O'Connor	KK6JXM
Past President	Patrick Coyle	KG6JSL

Committee Lineup/Contacts

Activities/Programs	Steve Bouchard, KK6VMZ	sb1112@outlook.com
Community Outreach	Darryl Paule, KI6MSP	ki6msp@arrl.net
DX/Contesting	Doug Payne, KF6LMB	dougpayne1@earthlink.net
Education	Dave Harrison, W6IBC	w6ibc@arrl.net
Emergency Services Liason	Pat Coyle, KG6JSL	coylaw@sonic.net
Field Day	Brian Torr, N6IY	n6iyy@arrl.net
Membership	ShelleyRae O'Connor, KK6JXM	kk6jxm@cpr4biz.com
Merchandise	Kathy Wells, KK6KGW	bikeladyofconcord@gmail.com
Public Service	Charlie Sikes, KZ6T	kz6t@arrl.net
Refreshments	ShelleyRae O'Connor, KK6JXM	kk6jxm@cpr4biz.com
Repeater	Jack Christensen, K6ROW	K6ROW@sonic.net
Volunteer Examiners	Brian Torr, N6IY	n6iyy@arrl.net
Webmaster	Sutter Laird, KI6ZON	ki6zon@me.com
Asst. Webmaster	ShelleyRae O'Connor, KK6JXM	kk6jxm@cpr4biz.com
Weekly Email Blog	Pat Coyle KG6JSL	coylaw@sonic.net

Short Skip & Web Staff

Editor	David Kraybill, KI6UGB	shortskipeditor@gmail.com
Webmaster	Sutter Laird, KI6ZON	ki6zon@me.com
Database Manager	Mike Von der Porten, AD6YB	mikevpca@aim.com

SCRA E-Mail K6SON@arrl.com
 SCRA Web site <http://www.sonomacountyradioamateurs.com>

Short Skip Advertising Rates

Business Cards	\$12 per month
1st Quarter Column	\$13 per month
Each Additional Quarter Column	\$4 per month
Full page (one side)	\$35 per month
Pre-printed inserts (each)	\$35 per month

Short Skip is published monthly and copyright 2015 by the Sonoma County Radio Amateurs, Inc. Permission to reprint articles is granted provided the source is properly credited. Items printed do not necessarily represent the views of the SCRA or its editors. Letters, photos and articles sent to Short Skip are subject to editing and may or may not be printed.



SCRA Club Meetings

The club normally meets the first Wednesday of each month, socially at 6:30 pm, program starting at 7:15 pm. Exceptions are holidays or other big events.

Meeting location:
 Luther Burbank Art & Garden Center
 2050 Yulupa Avenue
 Santa Rosa, CA

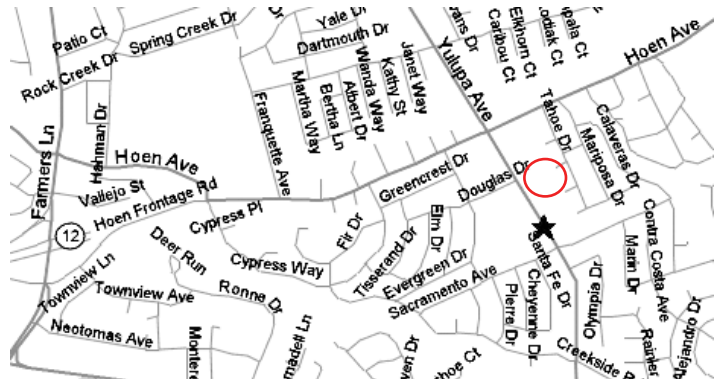

All are welcome!

Please join us at our next meeting. Anyone interested in Amateur Radio may be eligible for membership. A membership application is included in this newsletter.

For more information, contact any SCRA officer, director or member. Hungry before the meeting?

Join us for dinner! We Meet at IHOP restaurant, 4th and Farmers Lane, Santa Rosa. People start showing up at 5:15 PM. No RSVP is required.

Board of Directors Meeting

The SCRA Board of Directors will meet monthly on the Second Wednesday at the IHOP Restaurant, Fourth Street, Santa Rosa (in the Safeway/CVS Pharmacy center). All members are welcome to attend, no reservations necessary. Arrive around 5:15- 5:30pm for dinner. Meeting starts at 6:00pm. (Time changed to conform with bylaws)

SCRA LOANER RADIOS

SCRA has a Yeasu 2900 VHF radio available for use by members as a loaner. Contact Charlie, KZ6T, at charliesikes@me.com

UPGRADE TO GENERAL OR AMATEUR EXTRA CLASS

Get more privileges and enjoyment from your Ham Radio Hobby. Mentoring assistance is available. Contact Dave W6IBC, SCRA Education Chair, at 707-838-8155 or w6ibc@arrl.net.

Tuesday Night Net

The Sonoma County Radio Amateurs' net meets Tuesday at 7:00 PM on the SCRA repeater, 147.315, positive offset, PL 88.5.

All members and guests are invited to check in. The Net includes updates on SCRA activities, and News-line, the amateur radio community news service.

Anyone wishing to work as net control should contact lola kk6hre, at K6SON@ARRL.NET for assignment. Script and logs are available on the Website at <http://sonomacountyradioamateurs.com/wp/resources/net-script/>



10 Meter Net

There will be a net on 10 meters hosted by Joe K6AWA at 8:30pm (new time) following the regular SCRA net Tuesday nights. Set your dial to 28,402.00 SSB, USB. Please note that all license classes (including technician) are welcome.

2016 SCHEDULE OF EVENTS

Check the [Club website](#) for details

Sat, May 7 - Wine Country Century
 Sat, May 7 - Human Race
 Sat, May 21 - Tour d'California. Club may not be sponsoring
 Sun, May 22 - Monte Rio Vineman
 Sat, June 4 - VE Testing
 Sat, June 11 - TH-6 Antenna Assy and Erection Practice Session
 Sat, June 18 - ARRL Kids Day
 Sat, June 18 - Terrible Two
 Fri, Sat, and Sun, June 25-26 - Field Day
 Sat/Sun July 16-17 Mendocino Rally Not a Club Sponsored Event
 July 22 - August 7 - County Fair
 Saturday, August 13 - Annadel XC
 Sun August 14 -Tour d'Organics
 Sunday, August 21 - Santa Rosa Marathon
 Sat, August 27 - VE Testing
 Sat/Sun Sept 24-25 - Waves to Wine
 Sat Oct 1 - Levi's Gran Fondo
 Sat Oct 15 - Jamboree on the Air (JOTA)
 Sat Oct 29 - North Bay Science Discovery Day
 Sat, November 12 - VE Testing

PCAM dependent upon independent insurance coverage

Mini DX 2016

This is the annual camping/ radio adventure for the club members. The event will be at A.W.Way County Park west of Garberville, and just west of Honeydew in Humboldt County. Travel time from Santa Rosa is about 4 to 4.5 hours. The dates are Thursday August 5, Friday August 6, and Sunday August 7. As the date of the event gets closer, members either before or after the main days may add additional days. The cost for the camping sites is \$20 per night, allowing two vehicles per site. So carpool and share a site too. Hot showers are available for 75 cents. This year it will bring your own food, with a one-time potluck dinner.

The mini DX will have HF radio rigs, antennas to match for SSB, and CW. The event will also have 2-meter set-ups for KZ6T to do a repeat of his mountain top adventure. Members with Technician licenses would be welcomed, as they can find out what HF is all about. Perhaps they will make a QSO on HF.

Submitted by Doug Payne KF6LMB HF committee



CONTEST CORNER by Kevin Alt, K6BSG

Hello testers. Lots of digital contests in May along with the big CQWW contests. Days are longer and sunspot cycle 24 is just past its peak. Take advantage of the good HF conditions while they last. Happy DX'ing!

1 May – AGCW QRP Party – CW, 80-40 meters. See: www.agcw.org/index.php/en.

2 May – RSGB 80 Meter Club Championship – SSB, 80 meters. See: www.rsgbcc.org/hf.

3 May – ARS Spartan Sprint – CW, 80-10 meters. See: arsqrp.blogspot.com.

4-5 May – MIE 33 Contest – SSB/CW, all bands. See: www.ztv.ne.jp/isoda/33.

5 May – NRAU 10 Meter Activity Contest – all modes, 10 meters. See: www.nrau.net/activity-contests.

7 May – Microwave Spring Sprint – all modes, 902 MHz and above. See: sites.google.com/site/springvh-fupsprints.

7 May – FISTS Spring Slow Speed Sprint – CW, 80-10 meters. See: fistsna.org/operating.html#sprints.

7-8 May – 10-10 International Spring Contest – CW, 10 meters. See: www.ten-ten.org/index.php.

7-8 May – ARI International DX Contest – all modes, 160-10 meters. See: www.ari.it.

7-8 May – F9AA Cup – PSK, 80-2 meters. See: www.site.urc.asso.fr.

7-8 May – SKCC Weekend Sprintathon – CW, 160-6 meters. See: www.skccgroup.com.

7-8 May – 7th Call Area QSO Party – all modes, 160-2 meters. See: ws7n.net/7QP.

7-8 May – Indiana QSO Party – Phone/CW, 160-10 meters. See: www.hdxcc.org/inqp/rules.html.

7-8 May – Delaware QSO Party – all modes, 160-2 meters. See: www.fsarc.org/qsoparty/rules.htm.

7-8 May – New England QSO Party – all modes, 80-10 meters. See: www.neqp.org/rules.html.

11 May – RSGB 80 Meter Club Championship – Digital, 80 meters. See: www.rsgbcc.org/hf.

12 May – NAQCC CW Sprint – CW, 80-20 meters. See: naqcc.info/sprint201605.html.

14 May – FISTS Spring Unlimited Sprint – CW, 80-10 meters. See: fistsna.org/operating.html#sprints.

14-15 May – HPC World Wide DX Contest – Digital, 80-10 meters. See: pskclub.gr/contest.

14-15 May – CQ-M International DX Contest – SSB/CW, 160-10 meters. See: www.cq-m.ru/en/rules.html.

14-15 May – Volta WW RTTY Contest – RTTY, 80-10 meters. See: www.contestvolta.it.

14-15 May – Arkansas QSO Party – All modes, 80-2 meters. See: www.arkqsoparty.com/#!rules/c205y.

14-15 May – MARAC USA QSO Party – CW, 80-10 meters. See: countyhunter.com.

14-15 May – Portuguese Navy Day Contest – SSB/CW, 80-10 meters. See: www.nra.pt.

14-15 May – 50 MHz Spring Sprint – all modes, 6 meters. See: sites.google.com/site/springvhfupsprints.

15 May – WAB 7 MHz Phone – SSB, 40 meters. See: wab.intermip.net/Contests.php.

15 May – UA2 QSO Party – CW/SSB, 80-20 meters. See: www.qrz.ru/contest/detail/382.html.

16 May – Run for the Bacon QRP Contest – CW, 160-10 meters. See: fpqrp.org/pigrun/.

19 May – RSGB 80 Meter Club Championship – CW, 80 meters. See: www.rsgbcc.org/hf.

Continued on page 7...





Contest Corner continued from page 6...

20 May – Slobozhansky Sprint Contest – CW/SSB, 160-80 meters. See: tdr.at.ua/index/rules2015/0-13.

21 May – UN DX Contest – CW/SSB, 80-10 meters. See: undxc.kz/bez-rubriki/2015-2.

21 May – Feld Hell Sprint – Digital, 160-10 meters. See: sites.google.com/site/feldhellclub.

21-22 May – NZART Sangster Shield Contest – CW, 80 meters. See: www.nzart.org/activities.

21-22 May – Aegean RTTY Contest – Digital, 80-10 meters. See: www.aegeandxgroup.gr.

21-22 May – EU PSK DX Contest – PSK, 80-10 meters. See: www.eupsk.com.

21-22 May – His Majesty King of Spain Contest – CW, 160-10 meters. See: concursos.ure.es/en/.

21-22 May – Baltic Contest – CW/SSB, 80 meters. See: www.lrsf.lt/bcontest/english.

25 May – SKCC Sprint – CW, 160-10 meters. See: www.skccgroup.com.

28 May – Portuguese Navy Day Contest – Digital, 80-10 meters. See: www.nra.pt.

28-29 May – CQ WW WPX Contest – CW, 160-10 meters. See: www.cqwpw.com/rules.htm.

29 May – SARL Digital Contest – Digital, 80-20 meters. See: www.sarl.org.za.

For additional contest calendars and resources check:

[WA7BNM Contest Calendar](#)

[ARRL Contests Page](#)

Minutes, SCRA April 6, 2016, Membership Meeting

The April 2016 regular Membership meeting of SCRA was called to order by President Iola KK6HRE at 7:11 PM, following a 40 minute social hour. A quorum of members was present. After introduction of officers and directors, new members and guests were introduced, including Pete KG6YKO and Brian White (both representing the Mendo Rally), Alan KE6IDU, Marcus KG6GHW, James KI6RWG, Beth KK6UVC and her son Nathan, Bill Dornbush a former ham from the Red Cross. Ed N2WD, and Chris KM6BPS. Net Control Assignments:

April 12: Andrew KE6HID

April 19: Dennis KI6REO

April 26: Craig K6XLT

May 3: Joe K6AWA

Pete KG6YKO and Brian White spoke briefly about the Mendo Rally. Again, ham radio volunteers are needed. The race will be on July 9-10 in Mendocino County. Sign up on-line at www.rallydata.com. Volunteers will get a commemorative tee shirt, and they are covered under the rally insurance policy. Pete expects 15-20 entries.

This month's program featured SCRA Member Matt KJ6LJI and covered High Frequency Digital Modes. Digital modes involve converting text or data into audio signals with a computer for modulating a radio transmitter, using AM, FM or SSB. Equipment includes a ham transceiver, a personal computer with sound card, and a control interface, such as Rig Blaster, Signalink, or a homebrew interface. The system requires computer software implementing the particular digital mode., such as Ham Radio Deluxe, Digital Master 780, fldigi, and a number of other programs. Most are freeware, but some, like Ham Radio Deluxe, are licensed. Matt discussed and illustrated Radio Teletype (RTTY), Slow Scan Television (SSTV), Phase Shift Keying with 31 phases (PSK31), Weak Signal Digital mode JT-65 having forward error correction, and Weak Signal Propagation Reporter (WSPR). JT-5 and WSPR were created by Nobel Laureate Dr. Joe Taylor K1JT. Matt also mentioned a website locator, PSKReporter.info where you can see which stations receive your signal.

During a break Dave W6IBC auctioned off equipment donated to the club via Mike AD6YB.

Continued on page 8...

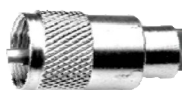



Minutes continued from page 7...

The business meeting commenced with Treasurer Wells KK6EXC reporting on the state of the treasury. Education Chair Dave W6IBC reported upon the successful Technician class and the follow-on class. And Iola KK6HRE reported that this Friday would be the last meeting of the CW class held by John WB6FRZ.

Public Service Chair Charlie KZ6T reported that the SoNoMas bike event at Lake Sonoma successfully marked the beginning of the Public Service season, and reviewed upcoming events. Craig K6XLT seeks volunteers for the AMGEN Tour of California on May 21st which will run all day long. Eric AA6EM, speaking on behalf of the City of Santa Rosa, reported that the ham radio communicators would provide backbone communications support for this event, so that hams can expect considerable radio activity.

Field Day Chair Brian N6IYY reported the next planning session will be April 16th at Youth Park at noon. He needs volunteers and Windows laptops for the event network. A two hour interview about Field Day will be broadcast on KOWS 107.3 MHz on the first Sunday in June. We will try to use social media for promotion and will establish a club twitter account.

HF Team leader Doug KF6LMB reported that the Mini-DX event will be first weekend of August at A.W Way Park west of Garberville. Merchandise Chair Kathy KK6KGW reported she's looking into new shirt designs. Outreach Chair Darryl KI6MSP mentioned past and upcoming outreach events.

Under Unfinished Business, the 2016 Roster has been sent out by email. Cross-reference pages will be added with the next update/revision. EmComm Chair Pat KG6JSL reported the Red Cross is having renewed interest in radio communications including ham radio. He also reported that Santa Rosa is proposing an ordinance related to "growing", but that the advocacy group is proposing square wave lamp ballasts which create untold radio interference. Minutes of the March 2016 Membership meeting were approved on motion by Doug KF6LMB, second by Darryl KI6MSP. The Art and Garden Center is increasing rent to \$100 per meeting over the next year. They also want floor cleaning after each event.

With no further business the meeting adjourned at 9:16 PM.

Minutes SCRA Board of Directors Meeting

April 13, 2015

The April 2016 Board of Directors meeting was called to order by President Iola KK6HRE at 6:04 PM at IHOP restaurant, 2745 4th Street, Santa Rosa. SCRA Board members present, included President Iola KK6HRE, Vice President Brian N6IYY, Treasurer Wells KK6EXC, Secretary Dave W6IBC, Director Joe K6AWA and Past President Pat KG6JSL. Other members in attendance included Dan WA6CRB, Charlie KZ6T, Darryl KI6MSP, Steve KK6VMZ, Jeff KI6PBF, Doug KF6LMB, and Mike K6HCU. .

Minutes of the March 2016 Board Meeting were approved on motion by Joe K6AWA, second by Iola KK6HRE.

Treasurer Wells KK6EXC reported that he continues to work on the audit.

President Iola KK6HRE reported that the club presently has 135 paid members. The 2016 SCRA Roster will be updated by June 30, 2016 and will include cross-reference name and callsign indexes as per the 2015 Roster.

Community Outreach Chair Darryl presented a written proposal that the club sponsor and support Brookhaven School in Sebastopol in its application for a ham radio contact with the International Space Station (ARISS). After discussion, the board took no action with request for \$200.00 for possible publicity expenses but did resolve to sponsor the application of Brookhaven School of Sebastopol for a ham radio contact with the ISS sometime in the early months of 2017, on motion by Dave W6IBC, second by Pat KG6JSL. President Iola KK6HRE will send a letter to the school.

Activities Chair Steve KK6VMZ continues to plan Club visits with other ham clubs in our area. President Iola KK6HRE will be attending the VOMARC hamfest and will discuss exchange of visits at that time and report back to the board.

Director Joe K6AWA reports receiving an email from Lake County reporting that a ham there lost his entire station in the fire and hopes that someone would be willing to donate high frequency equipment that is not currently in use. Joe will spread the word to the other clubs in Sonoma County.

Public Service Chair Charlie KZ6T reported that the SoNoMas bike race and the Lake Sonoma 50 footrace events went well, and that the Human Race and Wine Country Century are the next events on the public service calendar. As for the Amgen Tour of California, SCRA members should contact Matt KJ6LJI or Eric AA6EM for information.

The HF Mini-DX Chair Doug KF6LMB reported that this year's event will be held on August 5-7 at A.W. Way Park, near Petrolia west of Garberville, with camping and HF radio operation planned.

Continued on page 9...

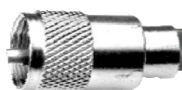



Board Meeting Minutes continued from page 8...

Repeater committee member Charlie KZ6T reported that the new 220 MHz repeater and antenna are in hand and will be installed. Also, a Raspberry Pi computer will be used to provide Winlink service at the English Hill site.

Field Day Chair Brian N6IYY reported that the agreement with Santa Rosa is completed, and that he is considering a modified site layout farther to the east at Youth Park. Next meeting will be Saturday April 16, 2016 at Youth Park at noon. Other meetings will address computer networking, and TH-6 antenna assembly practice.

Short Skip Editor Dave KI6UGB wants more articles from members for publication.

Dave W6IbC reported his findings regarding a club scholarship. A formal program must be established and approved by the IRS to ensure compliance with its rules governing tax advantaged non profits. The board took no action on establishing a scholarship program following this report. The issue of complementary memberships was also discussed with no action taken.

In response to a written request by member Mike AD6YB, the Board will investigate a separate source for insurance for PCAM's Wings over Wine Country. With the Mendo Rally organization providing insurance, the club will not seek insurance for that event.

Charlie KZ6T agreed to revise the club's promotional brochure. Member Mike K6HCU proposed obtaining 18 inch by 24 inch fabric SCRA Logo pennants for use at club-involved events and will look into the matter further and report back to the board.

The Board discussed an appearance by club officials on Radio Station KOWS on June 5th. Iola KK6HRE requested preparation of questions for the expected interview.

The Board discussed the power of the Public Service Chair to decline requests for participation at newly proposed events. Any approval of a new event requires board approval.

After discussion, Dave W6IBC moved and Joe K6AWA seconded a motion to set the Board meeting time at 6PM. The motion carried.

With no further business, the meeting was adjourned at 7:40 PM

Respectfully submitted,

David Harrison W6IBC
Secretary

Next Exam Session:

Our next exam session is scheduled for Saturday, June 4, from 9:00 am until noon. The location will be the First American Title Co, 627 College Ave, Santa Rosa. Walk-ins will be accepted and all test elements will be administered.

(<http://www.sonomacountyradioamateurs.com/ve-testing.html>) .

Please arrive by 8:45am to be signed in. Testing will begin shortly thereafter.

Directions: From Hwy 101, take College Ave East to Humboldt St.. Turn left onto Humboldt St. and then turn into the first parking lot on the left, behind First American Title Co. Enter through the rear door, just off from the parking lot.

Candidates should bring the following:

- One (1) photo ID or two (2) non-photo ID
- FCC Registration Number (FRN, if you have one) or Social Security Number (if you do not have an FRN) if you have had any FCC license assigned to you, amateur or otherwise, or had any prior business with the FCC, you probably have an FRN.
- Original and photocopy of your current amateur radio license (if licensed)
- Original and photocopy of any valid CSCEs (if applicable)
- #2 Pencil and eraser
- \$15.00 exam fee. Checks may be made payable to "ARRL-VEC"

Calculators may be used, but it must be demonstrated that all memories and programs have been erased. The calculator function in a cell phone or PDA may not be used! If you have any special needs, please contact Brian Torr, N6IYY in advance.

Good Luck!

Brian Torr, N6IYY
n6iiy@arrl.net
(707) 575-5871

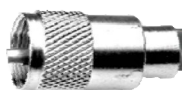



Field Day is Getting Closer!!

ALERT!! Field Day is just under two months away and plans are taking shape nicely.

The big event begins at around 5pm on Friday, June 24 and ending around 3pm on Sunday, June 26. The location will be the same as last year, Youth Community Park (aka Skateboard Park) at 1725 Fulton Rd, in Santa Rosa, across the road from Piner High School.

We've had two planning sessions so far and I'd like to thank all of those that participated. Lots of good ideas shared and some changes are being made from last year. For example:

- Station locations will be moved further east, toward the entry to the park. This should improve our visibility and shorten some coax runs.
- We will be adding sound-absorbing sheets to the tents reduce "audio interference" from the other stations and glare on the radio and computer screens
- We are planning for two SSB stations, – But we need operators for these stations! Please check in with Dennis Colthurst, KI6REO
- We are planning improved signage for Fulton Rd and the entrance to the park.
- Station captains have been assigned
- We will attempt to network the logging computers

Station Captains

Our Station Captains this year are as follows:

- SSB – Dennis Colthurst, KI6REO
- CW – Frank Oddy, NQ6E and Cornell Chesnik, W6HMN
- Get-On-The-Air (GOTA) – Joe Fortuna, K6AWA
- VHF/UHF/Satellite – Bob Arthur, KG6ZDN

Please contact the appropriate station captains if you would like to reserve an operating spot.

Educational Activity

The Educational Activity will take place at 2pm on Saturday, June 25 The activity will be learning how to solder a PL-259 connector on to RG8 (or similar) coax. If you have some other preference for cable, bring it and we'll help you. You will end up building a short coax assembly, suitable for interconnecting your radio with a tuner, filter, external amplifier, etc.

So, I want to hear from YOU if one or more of the following apply:

- You would like to volunteer for Field Day. Even if it's only for an hour or two, every little bit helps.
- You have suggestions, any suggestions, regarding Field Day.
- You are curious to know more about Field Day
- You have equipment or ideas that could be put to use on Field Day

Next Planning Meeting

I had hoped to have another planning meeting before the end of April, but due to a family emergency, that did not happen. Please look for our next meeting in May.

TH-6 Antenna Assembly and Erection Practice Session

On Saturday, June 11, at 9am, we will meet at Doug Payne, KF6LMB's QTH to practice assembling the TH-6 tri-band beam, mounting it onto the crank-up mast, and raising it to full height. Anyone intending to volunteer to participate in setup on Friday June 24 is strongly encouraged to come to this session. Knowing how to execute this part of the setup goes quickly and efficiently is key to ensuring that the rest of Field Day setup goes smoothly as well.

Let's make Field Day 2016 even better than last year!

Brian Torr, N6IYY
Tel: (707) 575-5871
n6iyy@arrl.net

MENDOCINO RALLY COMING JULY 9 – 10

The Mendocino Rally is returning July 9th and 10th and is welcoming all volunteers. If you have volunteered in the past you know how fun and fast both the cars, and radio traffic is at this great event. The Mendo Rally is not a S.C.R.A. event so you must volunteer at the Mendocino Rally website <http://www.mendocinorally.com/> If you have any questions please contact Pete Soper at pete1009@comcast.net or Jim Draeger jimdraeger5@gmail.com

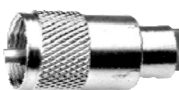



TO NET OR NOT TO NET WHEN? IS THE QUESTION (Reprinted)

Darv KK6OVH, March 2016

The following is a list of nets that can be heard in Sonoma County with a modest antenna. A quick scan of the following ninety-one nets will show that they fall into two time periods: Primarily in the morning and early evening, with very few occurring in the 9-5 workday hours. Each listing gives information on the day, time, name or organization sponsoring the net, frequency, shift, PL and the approximate location of the repeater. Multiple repeaters are listed when they are linked, but only the ones close enough to Sonoma County are listed. To keep the list current, please send corrections &/or omissions to kk6ovh@gmail.com.

VHF & UHF Nets

An emergency in the Santa Rosa area activates the SCRA ARES Nets at four times daily: 10AM, 2PM, 6PM, & 10PM, until the emergency subsides.

- 147.315 (+), PL 88.5 - Sebastopol Linked
- 147.315 (+), PL 156.7 - Santa Rosa Linked
- 147.315 simplex first, then 147.450 simplex for backup

Sunday

9:30 AM, Bathrobe ATV Net - 147.060 (+), PL 100.0 - Mt Diablo

- W6CXatv.net/live (to view the streaming videos on a computer)

10:15 AM, MARS ARES - ACS Repeater 146.700 (-), PL 179.9 - Mt Tamalpais

5:00 PM, Get Ready Marin CERT Net 146.910 (-), PL 88.5 - Dylan Beach

6:00 PM, ARC Comm Net - 443.975(+), PL 100 (marginal quality)

6:00 PM, LDS Collaborative Net - 147.060 (+), PL 100 - Mt Diablo

- 441.325 (+), PL 100 Linked to 147.060

6:30 PM, Danville EmComm Net - 147.060 (+), PL 100 - Mt Diablo

- 441.325 (+), PL 100 Linked to 147.060

6:35 PM, ARC Disaster Comm Forum - 443.975(+), PL 100.0

11:00 PM, WIN System Insomniac Net - 90+ repeaters, cell phone & computer

- 147.120 (+), PL 103.5 - Willits
- 224.360 (-), PL 88.5 - Healdsburg
- 441.300 (+), PL 88.5 - Santa Rosa
- 441.675 (+), PL 100.0 - Sugarloaf / Napa
- 443.000 (+). PL 100.0 - Laytonville
- 444.750 (+), PL 123.0 - Hopland / Santa Rosa
- WINSystem Info is an app for iPhones; listen only
- iTunes on a computer, Internet 2560.mp3; listen only

Monday

5:42 AM, MDARC Morning Muster Net - 147.060 (+), PL 100 - Mt Diablo

- 441.325 (+), PL 100.0 Linked to 147.060

6:10 AM, MDARC 6:10 Net - 147.060 (+), PL 100.0 - Mt Diablo

- 441.325 (+), PL 100 Linked to 147.060

7:10 AM, 4C's Over the Hill Commuter Net - 145.110 (-), PL 82.5 - San Pablo

9:00 AM, FARS Talk Net - 145.230 (-), PL 100.0 - Palo Alto

6:00 PM, 1st Monday of even months, McARCS linked countywide repeaters

- 147.390 (+), PL 103.5

6:15 / 7:00 PM, Sonoma County ACS Quarterly EOC Test - 146.730 (-), PL 88.5

2nd Monday

7:00Jan, 6:15Mar, 7:00Apr, 6:15Jun, 7Jul,

6:15Sep, 7Oct, 6:15Dec

- 224.820 (-), PL 103.5; Quarterly checkins only

- 453.025 (+), PL 127.3; Sheriff 6; Quarterly checkins only

6:30 PM, Russian River Unit ACS Net 145.190 (-), PL 88.5 - Guerneville

Forestville, Graton, Guerneville, Monte Rio

- 147.540 simplex

- 440.775 (+), PL 88.5

6:45 PM, Santa Rosa AECS / COPE - 146.790 (-), PL 88.5 - Santa Rosa

- 147.420 simplex backup

Continued on page 12...





TO NET... continued from page 11

7:00 PM, Sonoma County Wide ACS - 146.730 (-), PL 88.5 - Santa Rosa

- 147.480 simplex

- 146.565 simplex

~7:10 PM, Central County Unit ACS Net - 145.350 (-), PL 88.5 - Santa Rosa

Santa Rosa, Sebastopol

~7:15 PM, North County Unit ACS - 146.730 (-), PL 88.5 - Santa Rosa

Cloverdale, Healdsburg, Windsor

- 146.460 simplex

~7:15 PM, Sonoma Valley Unit ACS Net - 146.205 (+), PL 88.5 - Sonoma

Glen Ellen, Kenwood, Sonoma

- 147.480 simplex

- 146.565 simplex

~7:15 PM, South County Unit ACS Net - 146.910 (-), PL 88.5 - Petaluma

Cotati, Petaluma, Rohnert Park

- 145.170 (-), PL 88.5 Linked to 146.910

- 146.550 simplex

- 147.495 simplex

- 147.405 simplex

~7:30 PM, Tech Net - 146.910 (-), PL 88.5 - Petaluma

7:30 PM, SCRA ARES Net - 147.315 (+), PL 88.5 - Sebastopol

- 147.315 simplex then 147.450 simplex for backup

7:30 PM, BARC ACS Net - 442.750 (+), PL 100 - Benicia

- 441.250 (+), PL 100; used last Monday of the month

7:35 PM, Contra Costa Repeater Assoc Net - 145.490 (-), PL 107.2 Linked

- 145.410 (-), PL 107.2 - San Ramon Linked

- 147.735 (-), PL 107.2 - Concord Linked

7:30 PM, Benicia Amateur Radio Club - 441.250 PL 100.0

8:00 PM, SATERN, Concord - 147.060 (+), PL 100.0 - Mt Diablo

- 441.325 (+), PL 100 Linked to 147.060

8:00 PM, CDF Cal Fire Amateur Net - 147.180 (+), PL 151.4 - Mt St. Helena

- 441.900 (+), PL 151.4 - Mt St. Helena

8:30 PM, MVRC/YARS Roundtable Net - 147.000 (-), PL 136.5 - Mt Vaca

11:00 PM, WIN System Insomniac Net - 90+ repeaters, cell phone & computer

- 147.120 (+), PL 103.5 - Willits

- 224.360 (-), PL 88.5 - Healdsburg

- 441.300 (+), PL 88.5 - Santa Rosa

- 441.675 (+), PL 100.0 - Sugarloaf / Napa

- 443.000 (+). PL 100.0 - Laytonville

- 444.750 (+), PL 123.0 - Hopland / Santa Rosa

- WINSystem Info is an app for iPhones; listen only

- iTunes on a computer, Internet 2560.mp3; listen only

Tuesday

5:42 AM, MDARC Morning Muster Net - 147.060 (+), PL 100 - Mt Diablo

- 441.325 (+), PL 100.0 Linked to 147.060

6:10 AM, MDARC 6:10 Net - 147.060 (+), PL 100.0 - Mt Diablo

- 441.325 (+), PL 100 Linked to 147.060

7:10 AM, 4C's Over the Hill Commuter Net - 145.110 (-), PL 82.5 - San Pablo

9:00 AM, FARS Talk Net - 145.230 (-), PL 100.0 - Palo Alto

5:00 PM, MARS RACES Early Net - ACS 146.700 (-), PL 203.5

6:30 PM, ACS Net - 146.730 (-), PL 88.5; Linked to 147.975

7:00 PM, Bodega Bay Unit ACS Net - 147.975 (-), PL 88.5; Linked to 146.730

Bodega, Bodega Bay

- 146.670 (-), PL 88.5

- 145.350 (-), PL 88.5 linked to 146.670

- 146.205 (-), PL 107.2

- 146.415 simplex

7:00 PM, SCRA Service Net - SCRA Repeater - 147.315 (+), PL 88.5

- 147.315 simplex first, then 147.450 simplex for backup

7:15 PM, MARS Club RACES - Southern Marin - 147.555 Simplex

7:15 PM, MARS Club RACES - Central Marin - 147.510 Simplex

7:15 PM, MARS Club RACES - Northern Marin - 147.585 Simplex

Continued on page 13

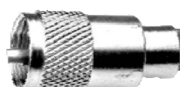



TO NET... continued from page 12

7:15 PM, MARS Club RACES - Western Marin - 147.330 (+), PL 179.9
 7:30 PM, MARS Club RACES Net - 146.700 (-), PL 203.5; K6GWE
 7:30 PM, QRM Net - 224.300 (-), PL 82.5
 ~7:40 PM, Code Practice Net - SCRA Repeater - 147.315 (+), PL 88.5
 8:00 PM, Petaluma Neighborhood Ham Net - 146.910 (-), PL 88.5 - Petaluma
 8:00 PM, Contra Costa Digital Practice Net - 224.780 (-), PL 77.0
 - 441.325 (+), PL 100.0
 11:00 PM, WIN System Insomniac Net - 90+ repeaters, cell phone & computer
 - 147.120 (+), PL 103.5 - Willits
 - 224.360 (-), PL 88.5 - Healdsburg
 - 441.300 (+), PL 88.5 - Santa Rosa
 - 441.675 (+), PL 100.0 - Sugarloaf / Napa
 - 443.000 (+). PL 100.0 - Laytonville
 - 444.750 (+), PL 123.0 - Hopland / Santa Rosa
 - WINSystem Info is an app for iPhones; listen only
 - iTunes on a computer, Internet 2560.mp3; listen only

Wednesday

5:42 AM, MDARC Morning Muster Net - 147.060 (+), PL 100 - Mt Diablo
 - 441.325 (+), PL 100.0 Linked to 147.060
 6:10 AM, MDARC 6:10 Net - 147.060 (+), PL 100.0 - Mt Diablo
 - 441.325 (+), PL 100 Linked to 147.060
 7:10 AM, 4C's Over the Hill Commuter Net - 145.110 (-), PL 82.5 - San Pablo
 9:00 AM, FARS Talk Net - 145.230 (-), PL 100.0 - Palo Alto
 12:00 AM, 4th Wed, Bay Area Hospital Net - 147.060 (+), PL 100 - Mt Diablo
 - 441.325 (+), PL 100 Linked to 147.060
 6:45 PM, Contra Costa Co Red Cross Net - 145.490 (-), PL 107.2 - Orinda
 - 145.410 (-), PL 107.2 - San Ramon
 - 147.735 (-), PL 107.2 - Concord
 7:00 PM, Lake County ARES - 146.775 PL 103.5
 7:00 PM, Sheriff RACES Net, Alameda Co. - 147.240 (+), PL 107.2
 7:00 PM, NARC Net - 146.820 (-), PL 151.4; Linked 147.180 (+), 151.4 - Napa

7:00 PM, Santa Clara Hospital Net - 145.230 (-), PL 100.0 - Palo Alto
 7:30 PM, VOMARC Club - 145.350 (-), PL 88.5; except 3rd Wed
 7:30 PM, McARCS Countywide Regional Nets - 147.390 (+), PL 103.5
 - 145.470 (+), PL 103.5 Hopland, South County
 - 147.675 (-), PL 179.9 Upper Lake, Lake County
 - 147.270 (+), PL 114.8 Anchor Bay, South Coast
 - 147.390 (+), PL 103.5 Central County
 - 145.430 (-), PL 103.5 North County
 7:30 PM, LaMarinda Net - 145.410 (-), PL 107.2 - San Ramon
 8:00 PM, ARC of the Bay Area - 443.975 (+), PL 100.0
 8:00 PM, Walking Repeater Net - 145.555 Simplex; Willits, Len WA6KLLK
 11:00 PM, WIN System Insomniac Net - 90+ repeaters
 - 147.120 (+), PL 103.5 - Willits
 - 224.360 (-), PL 88.5 - Healdsburg
 - 441.300 (+), PL 88.5 - Santa Rosa
 - 441.675 (+), PL 100.0 - Sugarloaf / Napa
 - 443.000 (+). PL 100.0 - Laytonville
 - 444.750 (+), PL 123.0 - Hopland / Santa Rosa
 - WINSystem Info is an app for iPhones; listen only
 - iTunes on a computer, Internet 2560.mp3; listen only

Thursday

5:42 AM, MDARC Morning Muster Net - 147.060 (+), PL 100 - Mt Diablo
 - 441.325 (+), PL 100.0 Linked to 147.060
 6:10 AM, MDARC 6:10 Net - 147.060 (+), PL 100.0 - Mt Diablo
 - 441.325 (+), PL 100 Linked to 147.060
 7:10 AM, 4C's Over the Hill Commuter Net - 145.110 (-), PL 82.5 - San Pablo
 9:00 AM, FARS Talk Net - 145.230 (-), PL 100.0 - Palo Alto
 7:00 PM, McARCS YL Net - 145.470 (+), PL 103.5 Hopland
 - 147.675 (-), PL 179.9 Upper Lake, Joyce KJ6ZVS
 - 147.270 (+), PL 114.8 Anchor Bay
 6:45 PM, West CC County EmComm Net - 145.110 (-), PL 82.5
 7:00 PM, EmComm Net, Vallejo - 147.180 (+), 151.4; Linked 146.820 (-), PL 151.4
 7:00 PM, ACS NBARA Net 145.310 (-), PL 88.5 - Vallejo; Linked 147.180
Continued on page 14





TO NET... continued from page 13

7:20 PM, RACES Contra Costa County-Wide Em-Comm Net

- 145.410 (-), PL 107.2 - San Ramon
- 145.490 (-), PL 107.2 - Orinda
- 147.735 (-), PL 107.2 - Concord

7:30 PM, 4C's Net - 145.110 (-), PL 82.5

7:30 PM, Northern Calif Ham Kids Net, Petaluma - 146.910 (-), PL 88.5; Puns

- 145.170 (-), PL 103.5 - Scotia (All Linked)
- 145.170 (-), PL 88.5 - Pt. Reyes
- 145.470 (-), PL 88.5 - Pt Reyes
- 145.655 (-), PL 103.5 - Laytonville
- 146.955 (-), PL 88.5 - Ukiah
- 146.970 (-), PL 103.5 - Cloverdale
- 147.150 (+), PL 103.5 - Garberville

7:30 PM, McARCS Swap Net - 147.390 (+), PL 103.5 - Central County

- 145.470 (+), PL 103.5 - Hopland
- 145.130 or 145.555 simplex
- 147.270 (+), PL 114.8 - Anchor Bay

7:30 PM, MDARC Net - 147.060 (+), PL 100 - Mt Diablo

- 441.325 (+), PL 100 Linked to 147.060

7:30 PM, ORCA ARES Net - 146.880 (-), PL 77.0 - Oakland

8:00 PM, FARS Net - 145.230 (-), PL 100.0 - Palo Alto

8:00 PM, General ATV Net - 147.060 (+), PL 100 - Mt Diablo

- W6CXatv.net/live (to view the streaming videos on a computer)

11:00 PM, WIN System Insomniac Net - 90+ repeaters, cell phone & computer

- 147.120 (+), PL 103.5 - Willits
- 224.360 (-), PL 88.5 - Healdsburg
- 441.300 (+), PL 88.5 - Santa Rosa
- 441.675 (+), PL 100.0 - Sugarloaf / Napa
- 443.000 (+). PL 100.0 - Laytonville
- 444.750 (+), PL 123.0 - Hopland / Santa Rosa
- WINSystem Info is an app for iPhones; listen only
- iTunes on a computer, Internet 2560.mp3; listen only

Friday

5:42 AM, MDARC Morning Muster Net - 147.060 (+), PL 100 - Mt Diablo

- 441.325 (+), PL 100.0 Linked to 147.060

6:10 AM, MDARC 6:10 Net - 147.060 (+), PL 100.0 - Mt Diablo

- 441.325 (+), PL 100 Linked to 147.060

7:10 AM, 4C's Over the Hill Commuter Net - 145.110 (-), PL 82.5 - San Pablo

9:00 AM, FARS Talk Net - 145.230 (-), PL 100.0 - Palo Alto

7:00 PM, WIN System Tech Net with Shorty

- 146.790 (-), PL 88.5 - Santa Rosa
- 147.120 (+), PL 103.5 - Willits

- 224.360 (-), PL 88.5 - Healdsburg

- 441.300 (+), PL 88.5 - Santa Rosa

- 441.675 (+), PL 100.0 - Sugarloaf

- 444.750 (+), PL 123.0 - Hopland

- WINSystem Info is an app for iPhones; listen only

- iTunes on a computer, Internet 2560.mp3; listen only

11:00 PM, WIN System Insomniac Net - 90+ repeaters, cell phone & computer

- 147.120 (+), PL 103.5 - Willits

- 224.360 (-), PL 88.5 - Healdsburg

- 441.300 (+), PL 88.5 - Santa Rosa

- 441.675 (+), PL 100.0 - Sugarloaf / Napa

- 443.000 (+). PL 100.0 - Laytonville

- 444.750 (+), PL 123.0 - Hopland / Santa Rosa

- WINSystem Info is an app for iPhones; listen only

- iTunes on a computer, Internet 2560.mp3; listen only

Saturday

9:00 AM, CS 245 Net - Moraga-Orinda Fire Dept

- 145.410 (-), PL 107.2 South Co - San Ramon

- 145.490 (-), PL 107.2 West Co - Orinda

- 147.735 (-), PL 107.2 Central and East - Concord

2:00 PM, FARS Youth Net - 145.230 (-), PL 100.0 - Palo Alto

7:45 PM, MVRC Mt Vaca Net 147.000 (-), PL 136.5

(Change ARS from +)

11:00 PM, WIN System Insomniac Net - 90+ repeaters, cell phone & computer

- 147.120 (+), PL 103.5 - Willits

- 224.360 (-), PL 88.5 - Healdsburg

- 441.300 (+), PL 88.5 - Santa Rosa

- 441.675 (+), PL 100.0 - Sugarloaf / Napa

- 443.000 (+). PL 100.0 - Laytonville

- 444.750 (+), PL 123.0 - Hopland / Santa Rosa

- WINSystem Info is an app for iPhones; listen only

- iTunes on a computer, Internet 2560.mp3; listen only

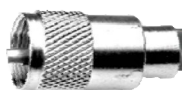



Sonomas Bike Race

Photos of the hams at Sonomas Bike Race this early afternoon (4/2/2016). The Net Control includes Charlie KZ6T, Pat KG6JSL and Matt KJ6LJI at the mike. He was the event Comm Boss.

Dave W6IBC



Keith KK6TAX





Sonoma County Radio Amateurs, Inc.
PO Box 116, Santa Rosa, CA 95402
(Please print this, fill it out, and send it in with your check.)

Name _____ Callsign _____ License Class _____
Mailing Address _____ Phone _____ Cell _____
City _____ Zip _____ New Application _____ Renewal _____
E-mail (if any) _____ Add to Roster (Yes)___ (No) ___

Please Send Short Skip & Roster to my E-mail address ()YES! () No thanks

FAMILY MEMBERS, CALL SIGNS & EMAIL ADDRESSES:

1. Name _____ Callsign _____ License Class _____ Add to Roster (Yes)___ (No) ___
E-mail _____ Short Skip & Roster to my E-mail address ()YES! () NO
2. Name _____ Callsign _____ License Class _____ Add to Roster (Yes)___ (No) ___
E-mail _____ Short Skip & Roster to my E-mail address ()YES! () NO
3. Name _____ Callsign _____ License Class _____ Add to Roster (Yes)___ (No) ___
E-mail _____ Short Skip & Roster to my E-mail address ()YES! () NO
4. Name _____ Callsign _____ License Class _____ Add to Roster (Yes)___ (No) ___
E-mail _____ Short Skip & Roster to my E-mail address ()YES! () NO

SCRA Dues: The renewal date for SCRA dues is January 1st. Dues are \$20/year for individual, \$30/year for families, and \$15/year for youth (under 18).

PRO-RATED DUES for new members only: Reduce standard dues rate by \$5.00 per quarter. (ie. Second Quarter, April – June \$15.00; Third Quarter – July – September \$10.00; Fourth Quarter, October – December \$5.00 to end of December of current year or \$25.00 through December of the following year)

I WOULD LIKE MORE INFORMATION ABOUT:

() Public Service Events () Acting as club Net Control Station
() ARES Emergency Services () Helping with VEC license exams
() Taking a Novice or Technician class () Field day, other operating
() Teaching a Novice or Technician class () Helping with *Short Skip* Newsletter
() Taking an upgrade class () Other _____
() Teaching an upgrade class

SCRA DUES: Individual \$20, Family \$30, Youth, under 18, \$15 + _____
Name Badge (complete info below) \$10 each Circle: Magnet or Clip attachment + _____

Name Badge Information Fill in exactly as you want it to appear on your badge.
Callsign _____ First Name _____ City _____
Callsign _____ First Name _____ City _____
Callsign _____ First Name _____ City _____

SCRA Patch \$5/ea + _____
SCRA T-Shirt \$11.50/ea Size: s m l xl xxl + _____

Total: \$ _____

(Please make checks payable to **SCRA**. Send to SCRA, Box 116, Santa Rosa, 95402)

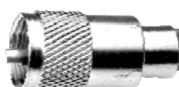

12 STORE BUYING POWER



HAM RADIO OUTLET
WORLDWIDE DISTRIBUTION

World's LARGEST HAM RADIO INVENTORY in stock for quick delivery

ANAHEIM, CA
(Near Disneyland)
933 N. Euclid St., 92801
(714) 533-7373
(800) 854-6046
Janet, KL7MF, Mgr.
anaheim@hamradio.com

BURBANK, CA
1525 W. Magnolia Bl., 91506
(818) 842-1786
(877) 892-1748
Eric, K6EJC, Mgr.
Magnolia between
S. Victory & Buena Vista
burbank@hamradio.com

OAKLAND, CA
2210 Livingston St., 94606
(510) 534-5757
(877) 892-1745
Nick, AK6DX, Mgr.
I-880 at 23rd Ave. ramp
oakland@hamradio.com

SAN DIEGO, CA
5375 Kearny Villa Rd., 92123
(858) 560-4900
(877) 520-9623
Jerry, N5MCJ, Mgr.
Hwy. 163 & Claremont Mesa
sandiego@hamradio.com

SUNNYVALE, CA
510 Lawrence Exp. #102
94085
(408) 736-9496
(877) 892-1749
Jon, K6WV, Mgr.
So. from Hwy. 101
sunnyvale@hamradio.com

NEW CASTLE, DE
(Near Philadelphia)
1509 N. Dupont Hwy., 19720
(302) 322-7092
(800) 644-4476
Ken, N2OHD, Mgr.
RT.13 1/4 mi., So. I-295
delaware@hamradio.com

PORTLAND, OR
11705 S.W. Pacific Hwy.
97223
(503) 598-0555
(800) 765-4267
Leon, W7AD, Mgr.
Tigard-99W exit
from Hwy. 5 & 217
portland@hamradio.com

DENVER, CO
8400 E. Iliff Ave. #9, 80231
(303) 745-7373
(800) 444-9476
John WØIG, Mgr.
denver@hamradio.com

PHOENIX, AZ
10613 N. 43rd Ave., 85029
(602) 242-3515
(800) 559-7388
Gary, N7GJ, Mgr.
Corner of 43rd Ave. & Peoria
phoenix@hamradio.com

ATLANTA, GA
6071 Buford Hwy., 30340
(770) 263-0700
(800) 444-7927
Mark, KJ4VO, Mgr.
Doraville, 1 mi. no. of I-285
atlanta@hamradio.com

WOODBRIIDGE, VA
(Near Washington D.C.)
14803 Build America Dr.
22191
(703) 643-1063
(800) 444-4799
Steve, W4SHG, Mgr.
Exit 161, I-95, So. to US 1
virginia@hamradio.com

SALEM, NH
(Near Boston)
224 N. Broadway, 03079
(603) 898-3750
(800) 444-0047
Dave, N1EDU, Mgr.
Exit 1, I-93,
28 mi. No. of Boston
salem@hamradio.com

KENWOOD



TS-2000 HF/VHF/UHF TCVR

- 100W HF, 6M, 2M • 50W 70CM • 10W 1.2GHz w/ opt UT-20 module • Built-in TNC, DX packet cluster
- IF Stage DSP • Backlit front key panel



TM-281A 2 Mtr Mobile

- 65 Watt • 200 Memories • CTCSS/DCS • Mil-Std specs • Hi-quality audio



TS-590S HF + 6M Transceiver

- 100W HF + 6M • 500 Hz & 2.7 KHz roofing filter
- Built-in auto tuner • Best dynamic range in class
- 32 bit DSP

TH-F6A 2M/220/440

- Dual channel receive • .1 - 1300 MHz (cell blocked) RX • FM, AM, SSB • 5W 2M/220/440 TX, FM • 435 Memories
- Li-Ion Battery



TM-V71A 2M/440 Dual Band

- High RF output (50W) • Multiple Scan • Dual receive on same band (VxV, UxU) • Echolink® memory (auto dialer) • Echolink® Sysop mode for node terminal ops

ICOM

IC-7000 All Mode Transceiver

- 160-10M/6M/2M/70CM
- 2x DSP • Digital IF filters
- Digital voice recorder
- 2.5" color TFT display



ID-51A VHF/UHF Dual Band Transceiver

- 5/2.5/1.0/0.5/0.1W Output • RX: 0.52-1.71, 88-174, 380-479 MHz** • AM/FM-FM-N/WFM/DV • 1304 Alphanumeric Memory Chls • Integrated GPS • D-STAR Repeater Directory • IPX7 Submersible



IC-7600 All Mode Transceiver

- 100W HF/6m Transceiver, gen cov. receiver • Dual DSP 32 bit • Three roofing filters- 3, 6, 15kHz • 5.8 in WQVGA TFT display • Hi-res real time spectrum scope



IC-V8000 2M Mobile Transceiver

- 75 watts • Dynamic Memory Scan (DMS)
- CTCSS/DCS encode/decode w/ tone scan • Weather alert • Weather channel scan • 200 alphanumeric memories

Analog + Digital Dual Bander D-STAR

ID-880H

- D-STAR DV mode operation • DR (D-STAR repeater) mode • Free software download • GPS A mode for easy D-PRS operation • One touch reply button (DV mode)
- Wideband receiver



YAesu
The radio



FTDX-3000 100W HF + 6M Transceiver

- 100 Watt HF/6 Meters • Large and wide color LCD display • High Speed Spectrum Scope built-in • 32 bit high speed DSP /Down Conversion 1st IF



FT-7900R 2M/440 Mobile

- 50W 2M, 45W on 440MHz • Weather Alert • 1000+ Memories • WIRES capability • Wideband receiver (cell blocked)

FT-60R 2M/440 5W HT

- Wide receiver coverage • AM air band receive • 1000 memory channels w/alpha labels • Huge LCD display • Rugged die-cast, water resistant case • NOAA severe weather alert with alert scan



FT-450D 100W HF + 6M Transceiver

- 100W HF/6M • Auto tuner built-in • DSP built-in
- 500 memories • DNR, IF Notch, IF Shift



FT-857D Ultra Compact HF/VHF/UHF

- 100w HF/6M, 50W 2M, 20W UHF • DSP included
- 32 color display • 200 mems • Detachable front panel (YSK-857 required)

AZ, CA, CO, GA, VA residents add sales tax. Prices, specifications, descriptions, subject to change without notice.

Come visit us online via the Internet at <http://www.hamradio.com>

#1 in Customer Service

COAST TO COAST FREE SHIPPING UPS - Most Items Over \$100 Rapid Deliveries From The Store Nearest to You!





SHORT SKIP ARCHIVES AVAILABLE

Mike, AD6YB, has set up archives for past and present issues of Short Skip. They are available on the Website, log into Members Area, Short Skip, click on the first sentence. Mike has scanned in the old paper issues and it is really interesting to browse through them to see what those guys were doing. There are historical photos as well. An important record of our history and ham radio in general. Good Stuff.

[\(Click Me\)](#)

DIDN'T FIND WHAT YOU NEEDED?

If you are looking for something more on a topic or your topic of interest hasn't been covered lately, let us know. Something you'd like to see in Short Skip?

Contact the editor, shortskipeditor@gmail.com or for general questions and /or suggestions, k6son@arrl.net

SHORT SKIP NEEDS YOUR INPUT

SHORT SKIP ARTICLES WANTED

Dave, KI6UGB, our Short Skip editor is always looking for articles of interest. They can be technical, a good (or bad) experience that other members may learn from, hints or kinks that worked for you in solving a problem, or just about anything ham radio related. Send your contributions to Dave at shortskipeditor@gmail.com

